



MULTI-CHANNEL LCD GAMMA CORRECTION BUFFER

FEATURES

- **Gamma Correction Channels: 6, 4**
- **Integrated V_{COM} Buffer**
- **Excellent Output Current Drive:**
 - **Gamma Channels: > 10mA**
 - **V_{COM} : > 100mA typ**
- **Large Capacitive Load Drive Capability**
- **Rail-to-Rail Output**
- **PowerPAD Package: BUF07703**
- **Low-Power/Channel: < 250 μ A**
- **Wide Supply Range: 4.5V to 16V**
- **Specified for 0°C to 85°C**
- **High ESD Rating: 4kV HBM, 1.5kV CDM**

APPLICATIONS

- **LCD Flat Panel Displays**
- **LCD Television Displays**

MODEL	GAMMA CHANNELS	VCOM CHANNELS
BUF07703	6	1
BUF06703	6	0
BUF05703	4	1

RELATED PRODUCTS

MODEL	GAMMA CHANNELS	VCOM CHANNELS
BUF11702	10	1
BUF04701	4	—
TLV2374	4	—

DESCRIPTION

The BUFxx703 are a series of multi-channel buffers targeted towards gamma correction in high-resolution liquid crystal display (LCD) panels. The number of gamma correction channels required depends on a variety of factors and differs greatly from design to design. Therefore, various channel options are offered. For additional space and cost savings, a V_{COM} channel with higher current drive capability is integrated in the BUF07703 and BUF05703.

A flow through pin out has been adopted to allow simple PCB routing and maintain the cost effectiveness of this solution. All inputs and outputs of the BUFxx703 incorporate internal ESD protection circuits that prevent functional failures at voltages up to 4kV HBM and 1.5kV CDM.

The various buffers within the BUFxx703 are carefully matched to the voltage I/O requirements for the gamma correction application. Each buffer is capable of driving heavy capacitive loads and offers fast load current switching. The V_{COM} channel has increased output drive of > 100mA and can handle even larger capacitive loads.

The BUF07703 is available in the HTSSOP PowerPAD™ package for dramatically increased power dissipation capability. The BUF06703 and BUF05703 are available in standard TSSOP-16 and TSSOP-14 packages.



Please be aware that an important notice concerning availability, standard warranty, and use in critical applications of Texas Instruments semiconductor products and disclaimers thereto appears at the end of this data sheet.

PowerPAD is a trademark of Texas Instruments. All other trademarks are the property of their respective owners.



This integrated circuit can be damaged by ESD. Texas Instruments recommends that all integrated circuits be handled with appropriate precautions. Failure to observe proper handling and installation procedures can cause damage.

ESD damage can range from subtle performance degradation to complete device failure. Precision integrated circuits may be more susceptible to damage because very small parametric changes could cause the device not to meet its published specifications.

ABSOLUTE MAXIMUM RATINGS

over operating free-air temperature range unless otherwise noted⁽¹⁾

PARAMETERS	BUFXX703	UNIT
Supply, V_{DD} ⁽²⁾	16.5	V
Input Voltage Range, V_I	V_{DD}	V
Continuous Total Power Dissipation	See Dissipation Rating Table	
Operating Free-Air Temperature Range, T_A	0 to +85	°C
Maximum Junction Temperature, T_J	150	°C
Storage Temperature Range, T_{STG}	-65 to 150	°C
Lead Temperature 1.6mm (1/16 inch) from Case for 10s	260	°C

(1) Stresses beyond those listed under “absolute maximum ratings” may cause permanent damage to the device. These are stress ratings only, and functional operation of the device at these or any other conditions beyond those indicated under “recommended operating conditions” is not implied. Exposure to absolute-maximum-rated conditions for extended periods may affect device reliability.

(2) All voltage values are with respect to GND.

ORDERING INFORMATION

PRODUCT	PACKAGE-LEAD	PACKAGE DESIGNATOR ⁽¹⁾	SPECIFIED TEMPERATURE RANGE	ORDERING NUMBER	TRANSPORT MEDIA, QUANTITY
BUF07703	HTSSOP-20	PWP	0°C to +85°C	BUF07703PWP	Tube, 70
				BUF07703PWPR	Reels, 2000
BUF06703	TSSOP-16	PW	0°C to +85°C	BUF06703PW	Tube, 90
				BUF06703PWR	Reels, 2000
BUF05703	TSSOP-14	PW	0°C to +85°C	BUF05703PW	Tube, 90
				BUF05703PWR	Reels, 2000

(1) For the most current specification and package information, refer to our web site at www.ti.com.

DISSIPATION RATING TABLE

PACKAGE TYPE	PACKAGE DESIGNATOR	θ_{JC} (°C/W)	θ_{JA} (°C/W)	$T_A \leq 25^\circ\text{C}$ POWER RATING
TSSOP-20 PowerPAD	PWP (20)	1.40 ⁽¹⁾	32.63 ⁽¹⁾	3.83W ⁽¹⁾
TSSOP-16	PW (16)	—	108	1.15W
TSSOP-14	PW (14)	—	112	1.11W

(1) Thermal specifications assume 2oz trace and copper pad with solder.

RECOMMENDED OPERATING CONDITIONS

	MIN	NOM	MAX	UNIT
Supply Voltage, V_{DD}	4.5		16	V
Operating Free-Air Temperature, T_A	0		+85	°C
Junction Temperature	TSSOP-20 PowerPAD		+125	°C
	TSSOP-16, 14		+150	°C

EQUIVALENT SCHEMATICS OF INPUTS AND OUTPUTS

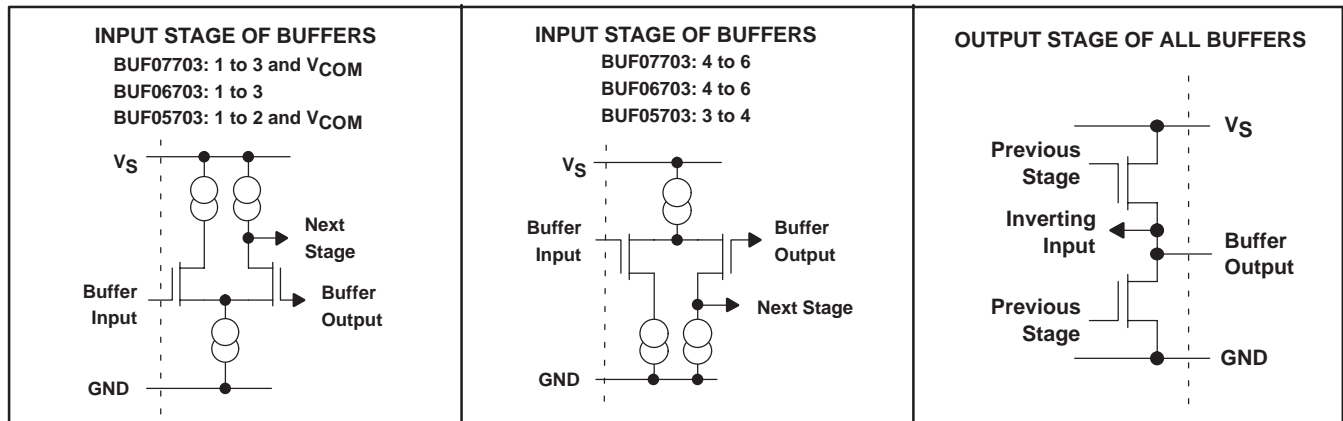

ELECTRICAL CHARACTERISTICS

over operating free-air temperature range, V_{DD} = 4.5V to 16V, T_A = 25°C, unless otherwise noted.

PARAMETER			TEST CONDITIONS	T _A †	MIN	TYP	MAX	UNIT
V _{IO}	Input offset voltage		V _I = V _{DD} /2, R _S = 50 Ω	25°C		1.5	12	mV
				Full Range(1)			15	
I _{IB}	Input bias current		V _I = V _{DD} /2	25°C		1		pA
				Full Range(1)		200		
k _{SVR}	Supply voltage rejection ratio (ΔV _{DD} /ΔV _{IO})		V _{DD} = 4.5V to 16V	25°C	62	80		dB
				Full Range(1)	60			
Buffer gain			V _I = 5V	25°C	0.9995			V/V
BW_3dB	3dB Bandwidth	Gamma Buffers V _{COM} Buffer	C _L = 100pF, R _L = 2kΩ	25°C		0.8 0.7		MHz
SR	Slew Rate	Gamma Buffers V _{COM} Buffer	C _L = 100pF, R _L = 2kΩ V _{IN} = 2V to 8V	25°C		1 0.7		V/μs
	Transient Load Regulation		I _O = 0 to ±5mA V _O = 5V C _L = 100pF t _T = 0.1μs	25°C		900		mV
	Transient Load Response		See Figure 2	25°C		160		mV
t _S (I-sink)	Settling Time–Current		I _O = 0 to –5mA V _O = 5V C _L = 100pF R _L = 2kΩ	Full Range(1)		1		μs
t _S (I-src)	Settling Time–Current		I _O = 0 to +5mA V _O = 5V C _L = 100pF R _L = 2kΩ	Full Range(1)		2		μs
t _S	Settling Time–Voltage	Gamma Buffers	V _I = 4.5V to 5.5V 0.1% V _I = 5.5V to 4.5V 0.1%	25°C		6 4.6		μs
		V _{COM} Buffer	V _I = 4.5V to 5.5V 0.1% V _I = 5.5V to 4.5V 0.1%			5.8 5.6		μs
V _n	Noise Voltage	Gamma Buffers V _{COM} Buffer	V _I = 5V f = 1kHz	25°C		45 40		nV/√Hz
	Crosstalk		V _{IP-P} = 6V, f = 1kHz	25°C		85		dB

(1) Full Range is 0°C to +85°C.

ELECTRICAL CHARACTERISTICS: BUF07703

over operating free-air temperature range, $V_{DD} = 4.5V$ to $16V$, $T_A = 25^\circ C$, unless otherwise noted.

PARAMETER		TEST CONDITIONS	$T_A^{(1)}$	MIN	TYP	MAX	UNIT
I_{DD}	Supply Current	ALL	$V_O = V_{DD}/2$, $V_I = V_{DD}/2$ $V_{DD} = 10V$	25°C	1.7	2	mA
				Full Range			3
Common Mode Input Range	Buffers 1–3		25°C	1		V_{DD}	V
	Buffers 4–6			0		$V_{DD}-1$	
	V_{COM} Buffer			1		V_{DD}	
Load regulation	V_{COM} buffer sinking	$V_{DD} = 10V$, $I_O = 1mA$ to $30mA$	25°C		1		mV/mA
	V_{COM} buffer sourcing	$V_{DD} = 10V$, $I_O = -1mA$ to $-30mA$	25°C		1		
	Buffers 1–6 sinking	$V_{DD} = 10V$, $I_O = 1mA$ to $10mA$	25°C		0.85		
	Buffers 1–6 sourcing	$V_{DD} = 10V$, $I_O = -1mA$ to $-10mA$	25°C		0.85		
V_{OSH1}	High-level saturated output voltage	Buffer 1	$V_{DD} = 16V$, $V_I = 16V$, $I_O = -5mA$	25°C	15.85	15.9	V
				Full range	15.8		
V_{OSL6}	Low-level saturated output voltage	Buffer 6	$V_{DD} = 16V$, $V_I = 0V$, $I_O = 5mA$	25°C		0.1 0.15	V
				Full range		0.2	
V_{OH1}	High-level output voltage	Buffer 1	$V_{DD} = 10V$, $V_I = 9.8V$, $I_O = -10mA$	25°C	9.75	9.8	V
$V_{OH2/3}$		Buffer 2/3	$V_{DD} = 10V$, $V_I = 9.5V$, $I_O = -10mA$	25°C	9.45	9.5	
					Full range	9.4	
$V_{OH4/5}$		Buffer 4/5	$V_{DD} = 10V$, $V_I = 8V$, $I_O = -10mA$	25°C	7.95	8	V
					Full range	7.9	
V_{OH6}		Buffer 6	$V_{DD} = 10V$, $V_I = 8V$, $I_O = -10mA$	25°C	7.95	8	V
	Full range				7.9		
V_{OHCOM}	V_{COM} Buffer	$V_{DD} = 10V$, $V_I = 8V$, $I_O = -30mA$	25°C	7.95	8	V	
V_{OL1}	Low-level output voltage	Buffer 1	$V_{DD} = 10V$, $V_I = 2V$, $I_O = 10mA$	25°C		2 2.05	V
					Full range		
$V_{OL2/3}$		Buffer 2/3	$V_{DD} = 10V$, $V_I = 2V$, $I_O = 10mA$	25°C		2 2.05	V
					Full range		
$V_{OL4/5}$		Buffer 4/5	$V_{DD} = 10V$, $V_I = 0.5V$, $I_O = 10mA$	25°C		0.5 0.55	V
					Full range		
V_{OL6}	Buffer 6	$V_{DD} = 10V$, $V_I = 0.2V$, $I_O = 10mA$	25°C		0.2 0.25	V	
				Full range			0.3
V_{OLCOM}	V_{COM} Buffer	$V_{DD} = 10V$, $V_I = 2V$, $I_O = 30mA$	25°C		2 2.05	V	
				Full range			2.1

(1) Full Range is 0°C to +85°C.

ELECTRICAL CHARACTERISTICS: BUF06703

 over operating free-air temperature range, $V_{DD} = 4.5V$ to $16V$, $T_A = 25^\circ C$, unless otherwise noted.

PARAMETER		TEST CONDITIONS	$T_A^{(1)}$	MIN	TYP	MAX	UNIT	
I_{DD}	Supply Current	ALL	$V_O = V_{DD}/2$, $V_I = V_{DD}/2$ $V_{DD} = 10V$	25°C	1.7	2	mA	
				Full Range		3	mA	
Common Mode Input Range		Buffers 1–3	25°C	1		V_{DD}	V	
		Buffers 4–6		0		$V_{DD}-1$		
Load regulation		Buffers 1–6 sinking	$V_{DD} = 10V$, $I_O = 1mA$ to $10mA$	25°C	0.85		mV/mA	
		Buffers 1–6 sourcing	$V_{DD} = 10V$, $I_O = -1mA$ to $-10mA$	25°C	0.85			
V_{OSH1}	High-level saturated output voltage	Buffer 1	$V_{DD} = 16V$, $V_I = 16V$	$I_O = -5mA$	25°C	15.85	15.9	V
					Full range	15.8		
V_{OSL6}	Low-level saturated output voltage	Buffer 6	$V_{DD} = 16V$, $V_I = 0V$	$I_O = 5mA$	25°C	0.1	0.15	V
					Full range		0.2	
V_{OH1}	High-level output voltage	Buffer 1	$V_{DD} = 10V$, $V_I = 9.8V$	$I_O = -10mA$	25°C	9.75	9.8	V
					Full range	9.7		
$V_{OH2/3}$		Buffer 2/3	$V_{DD} = 10V$, $V_I = 9.5V$	$I_O = -10mA$	25°C	9.45	9.5	V
					Full range	9.4		
$V_{OH4/5}$		Buffer 4/5	$V_{DD} = 10V$, $V_I = 8V$	$I_O = -10mA$	25°C	7.95	8	V
					Full range	7.9		
V_{OH6}		Buffer 6	$V_{DD} = 10V$, $V_I = 8V$	$I_O = -10mA$	25°C	7.95	8	V
					Full range	7.9		
V_{OL1}	Low-level output voltage	Buffer 1	$V_{DD} = 10V$, $V_I = 2V$	$I_O = 10mA$	25°C	2	2.05	V
					Full range		2.1	
$V_{OL2/3}$		Buffer 2/3	$V_{DD} = 10V$, $V_I = 2V$	$I_O = 10mA$	25°C	2	2.05	V
					Full range		2.1	
$V_{OL4/5}$		Buffer 4/5	$V_{DD} = 10V$, $V_I = 0.5V$	$I_O = 10mA$	25°C	0.5	0.55	V
					Full range		0.6	
V_{OL6}		Buffer 6	$V_{DD} = 10V$, $V_I = 0.2V$	$I_O = 10mA$	25°C	0.2	0.25	V
					Full range		0.3	

 (1) Full Range is $0^\circ C$ to $+85^\circ C$.

ELECTRICAL CHARACTERISTICS: BUF05703

over operating free-air temperature range, $V_{DD} = 4.5V$ to $16V$, $T_A = 25^\circ C$, unless otherwise noted.

PARAMETER		TEST CONDITIONS	$T_A^{(1)}$	MIN	TYP	MAX	UNIT
I_{DD}	Supply Current	ALL	$V_O = V_{DD}/2$, $V_I = V_{DD}/2$ $V_{DD} = 10V$	25°C	1.7	2	mA
				Full Range			3
Common Mode Input Range	Buffers 1–2		25°C	1		V_{DD}	V
	Buffers 3–4			0	$V_{DD}-1$		
	V_{COM} Buffer			1	V_{DD}		
Load regulation	V_{COM} buffer sinking	$V_{DD} = 10V$, $I_O = 1mA$ to $30mA$	25°C		1		mV/mA
	V_{COM} buffer sourcing	$V_{DD} = 10V$, $I_O = -1mA$ to $-30mA$	25°C		1		
	Buffers 1–4 sinking	$V_{DD} = 10V$, $I_O = 1mA$ to $10mA$	25°C		0.85		
	Buffers 1–4 sourcing	$V_{DD} = 10V$, $I_O = -1mA$ to $-10mA$	25°C		0.85		
V_{OSH1}	High-level saturated output voltage	Buffer 1	$V_{DD} = 16V$, $V_I = 16V$, $I_O = -5mA$	25°C	15.85	15.9	V
				Full range	15.8		
V_{OSL4}	Low-level saturated output voltage	Buffer 4	$V_{DD} = 16V$, $V_I = 0V$, $I_O = 5mA$	25°C		0.1 0.15	V
				Full range		0.2	
V_{OH1}	High-level output voltage	Buffer 1	$V_{DD} = 10V$, $V_I = 9.8V$, $I_O = -10mA$	25°C	9.75	9.8	V
V_{OH2}		Buffer 2	$V_{DD} = 10V$, $V_I = 9.5V$, $I_O = -10mA$	25°C	9.45	9.5	
				Full range	9.4		
V_{OH3}		Buffer 3	$V_{DD} = 10V$, $V_I = 8V$, $I_O = -10mA$	25°C	7.95	8	V
V_{OH4}		Buffer 4	$V_{DD} = 10V$, $V_I = 8V$, $I_O = -10mA$	25°C	7.95	8	
				Full range	7.9		
V_{OHCOM}	V_{COM} Buffer	$V_{DD} = 10V$, $V_I = 8V$, $I_O = -30mA$	25°C	7.95	8	V	
Full range	7.9						
V_{OL1}	Low-level output voltage	Buffer 1	$V_{DD} = 10V$, $V_I = 2V$, $I_O = 10mA$	25°C		2 2.05	V
V_{OL2}		Buffer 2	$V_{DD} = 10V$, $V_I = 2V$, $I_O = 10mA$	25°C		2 2.05	
				Full range		2.1	
V_{OL3}		Buffer 3	$V_{DD} = 10V$, $V_I = 0.5V$, $I_O = 10mA$	25°C		0.5 0.55	V
				Full range		0.6	
V_{OL4}		Buffer 4	$V_{DD} = 10V$, $V_I = 0.2V$, $I_O = 10mA$	25°C		0.2 0.25	V
	Full range				0.3		
V_{OLCOM}	V_{COM} Buffer	$V_{DD} = 10V$, $V_I = 2V$, $I_O = 30mA$	25°C		2 2.05	V	
Full range		2.1					

(1) Full Range is $0^\circ C$ to $+85^\circ C$.

BUF07703 Pin Configuration and Landing Pattern

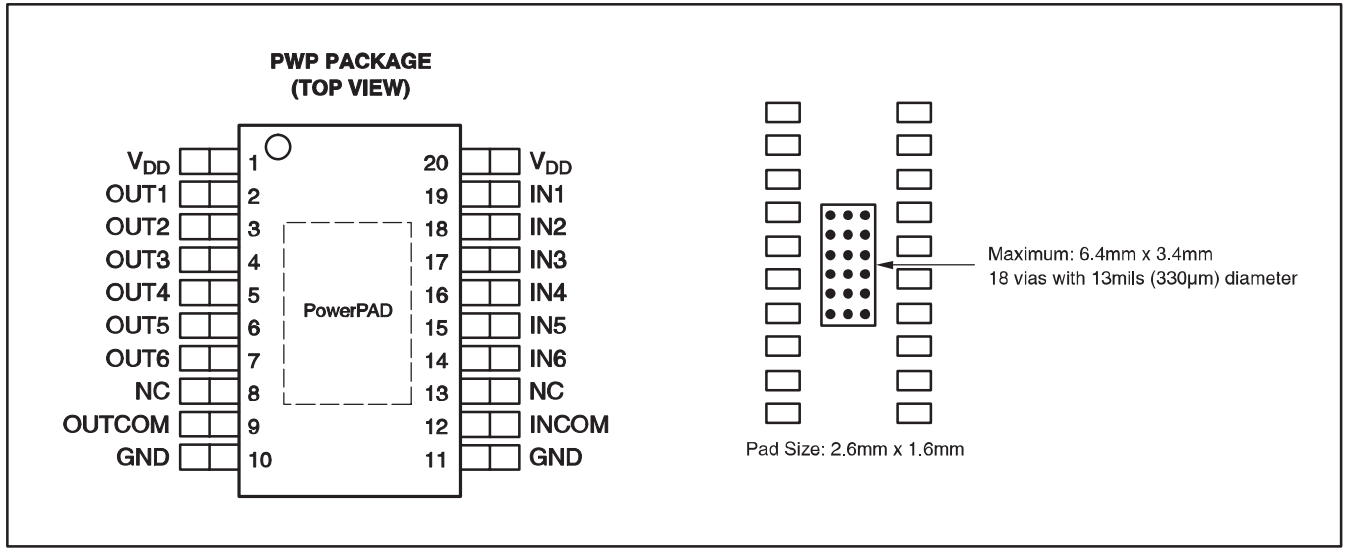

BUF06703 Pin Configuration

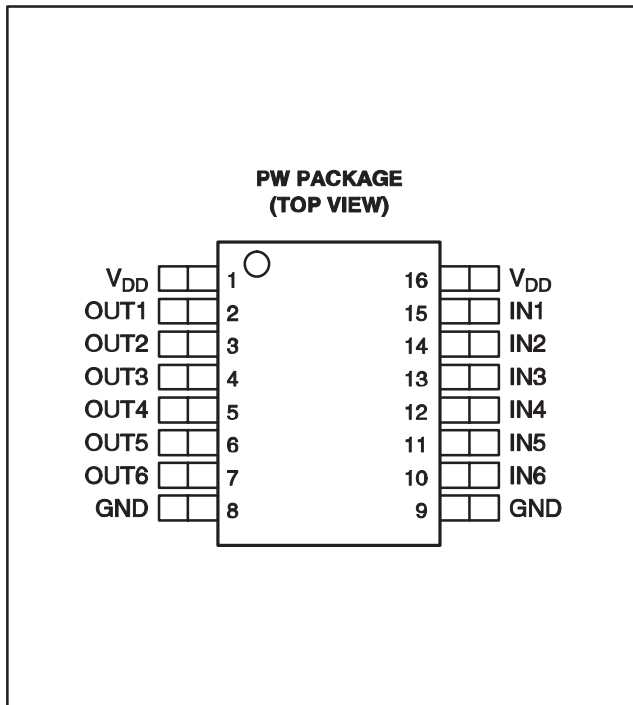

BUF05703 Pin Configuration

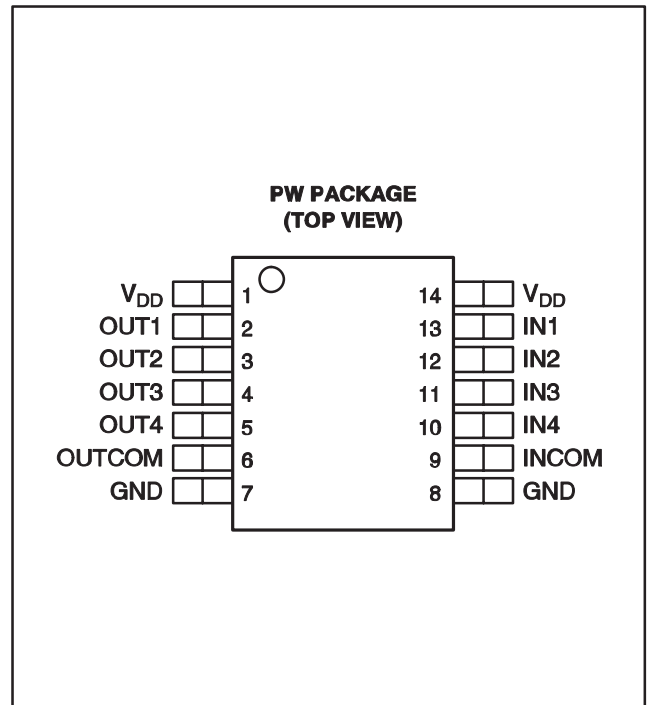

PARAMETER MEASUREMENT INFORMATION

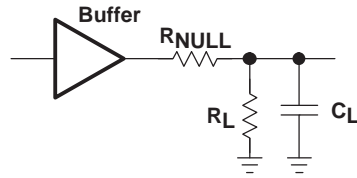
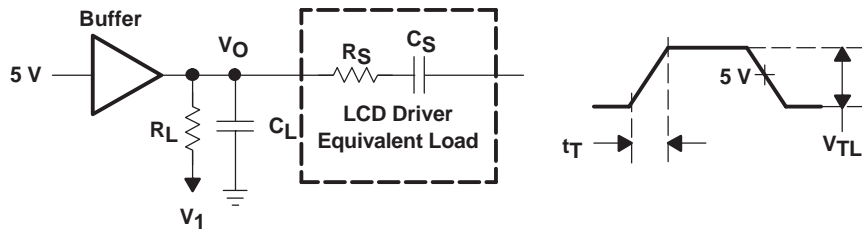

Figure 1. Bandwidth and Phase Shift Test Circuit



Test		V ₁	V _{TL}	t _T	C _S	R _S	C _L	R _L
Source	Gamma Channels	0 V	2 V	0.1 μs	100 pF	100 Ω	100 pF	1 kΩ
Sink	Gamma Channels	10 V	2 V	0.1 μs	100 pF	100 Ω	100 pF	1 kΩ

Figure 2. Transient Load Response Test Circuit

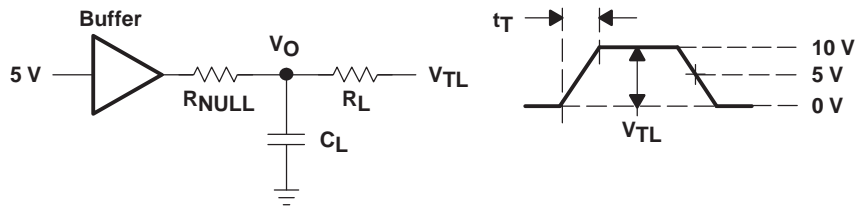

Figure 3. Transient Load Regulation Test Circuit

TYPICAL CHARACTERISTICS

DC CURVES

$V_{DD} = 10V$, unless otherwise noted.

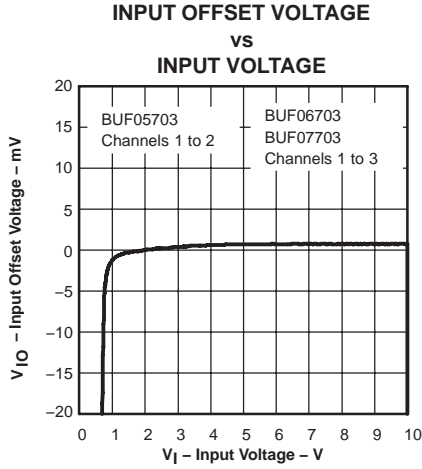

Figure 4

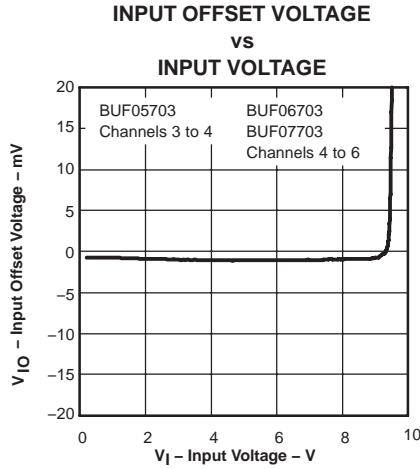

Figure 5

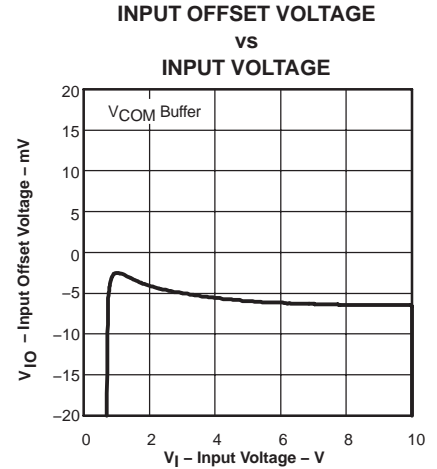

Figure 6

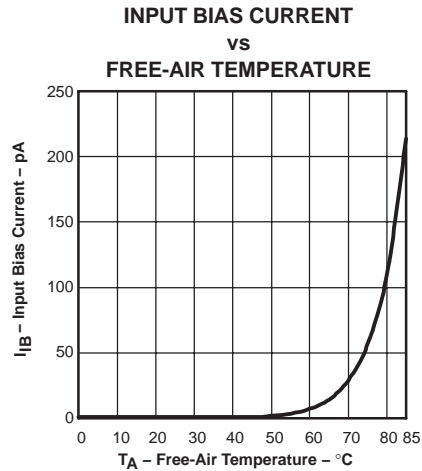

Figure 7

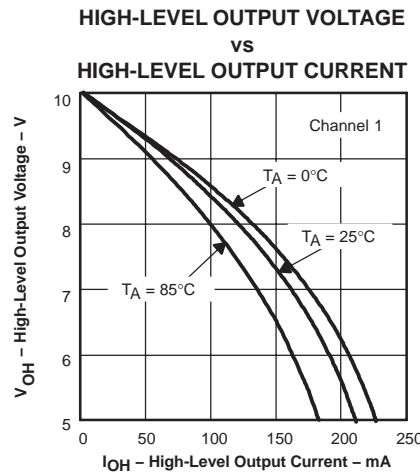

Figure 8

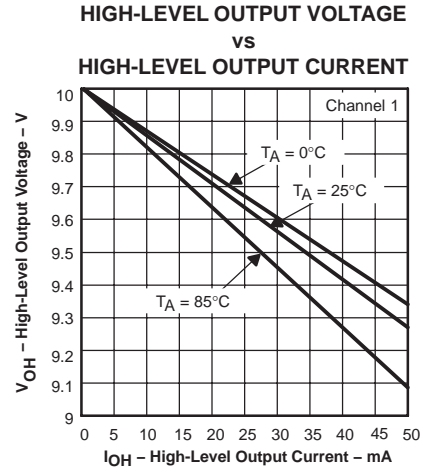

Figure 9

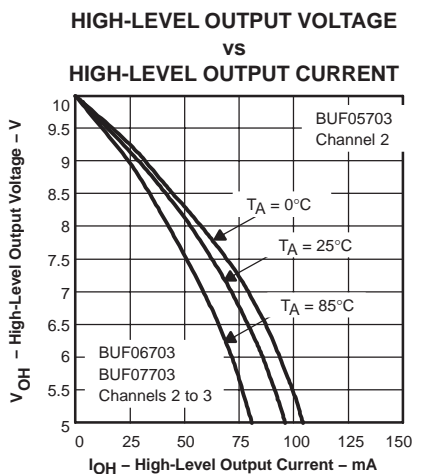

Figure 10

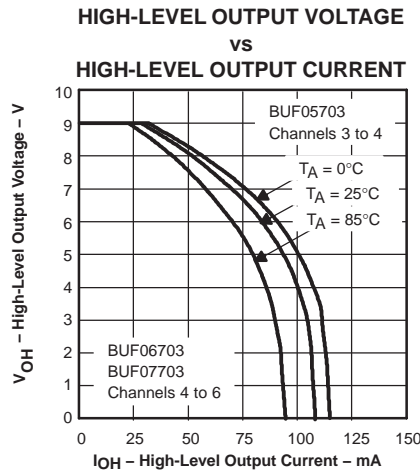

Figure 11

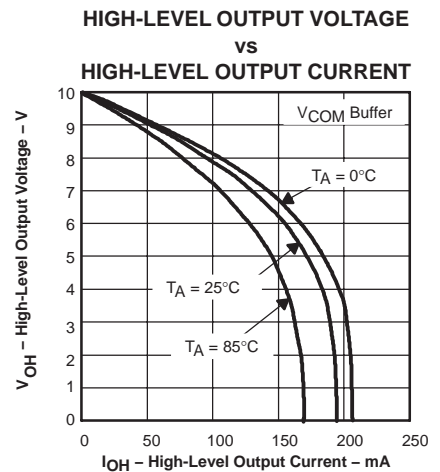

Figure 12

TYPICAL CHARACTERISTICS

DC CURVES (continued)

$V_{DD} = 10V$, unless otherwise noted.

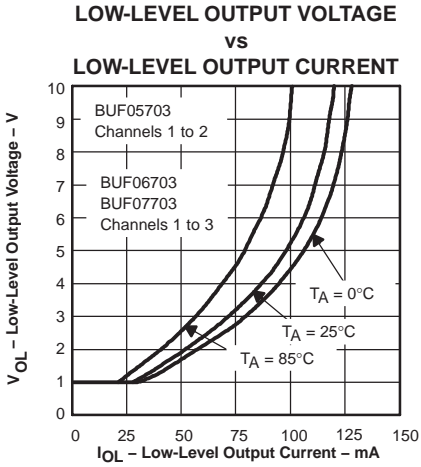

Figure 13

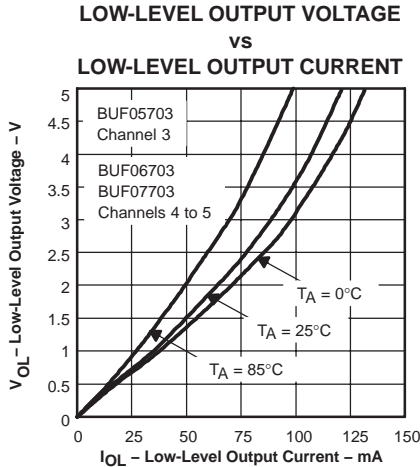

Figure 14

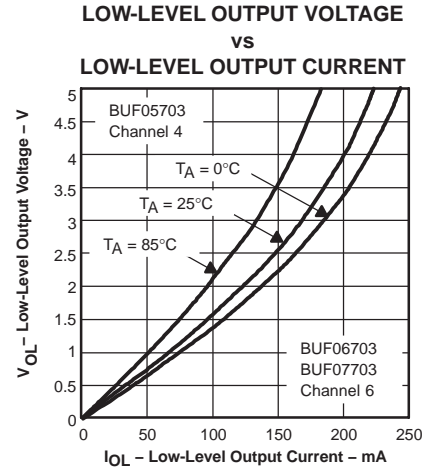

Figure 15

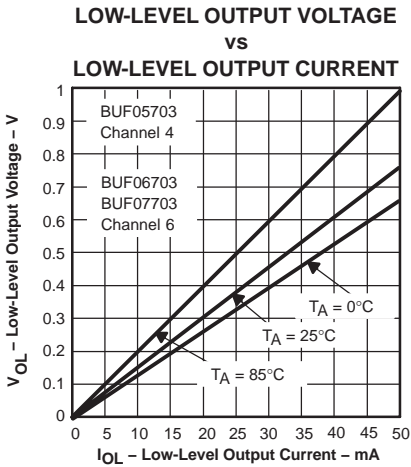

Figure 16

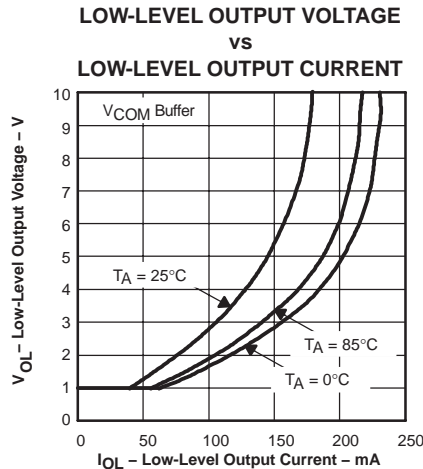

Figure 17

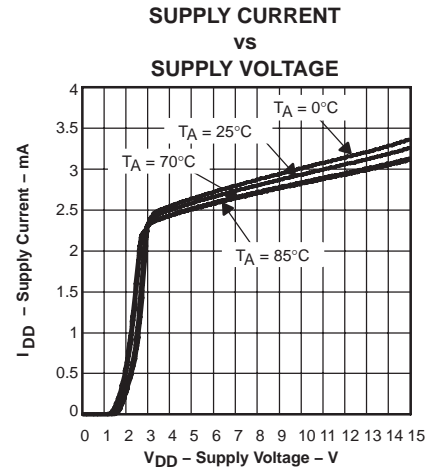

Figure 18

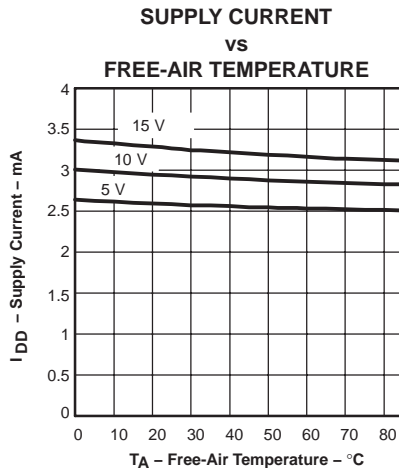

Figure 19

TYPICAL CHARACTERISTICS

AC CURVES

$V_{DD} = 10V$, unless otherwise noted.

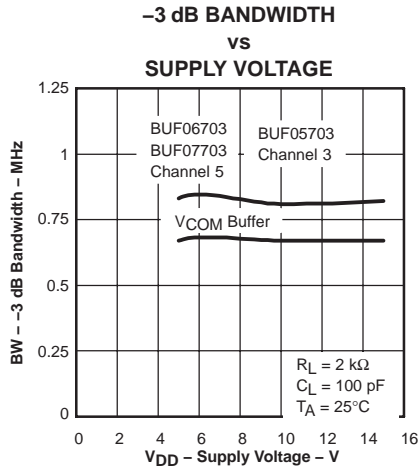

Figure 20

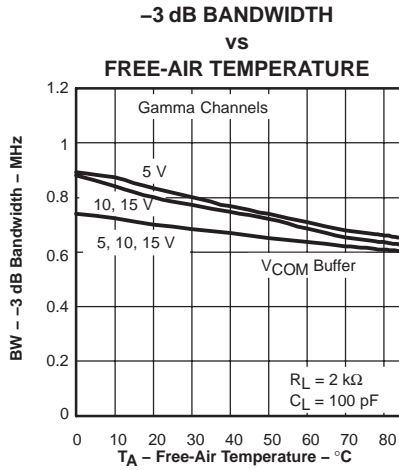

Figure 21

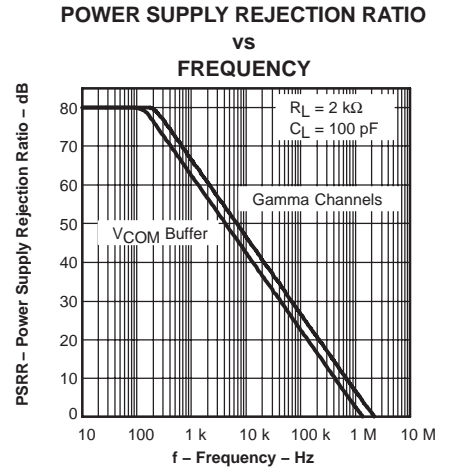

Figure 22

TYPICAL CHARACTERISTICS

TRANSIENT CURVES

SUPPLY VOLTAGE, OUTPUT VOLTAGE
 AND SUPPLY CURRENT

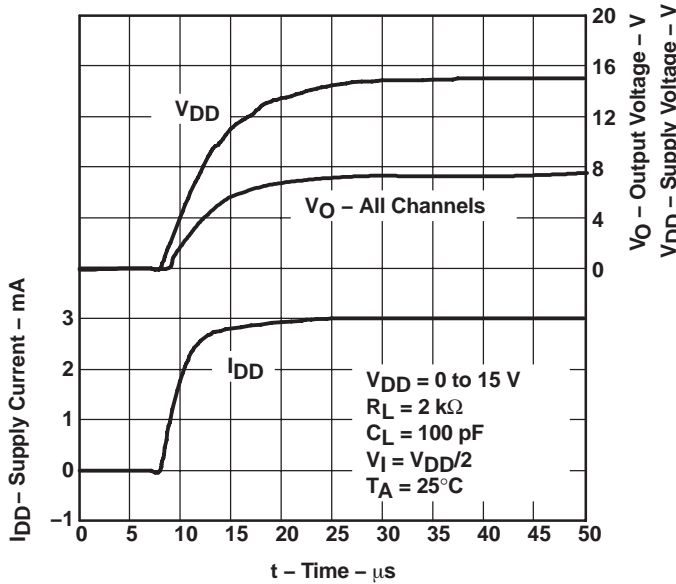

Figure 23

LARGE SIGNAL VOLTAGE FOLLOWER

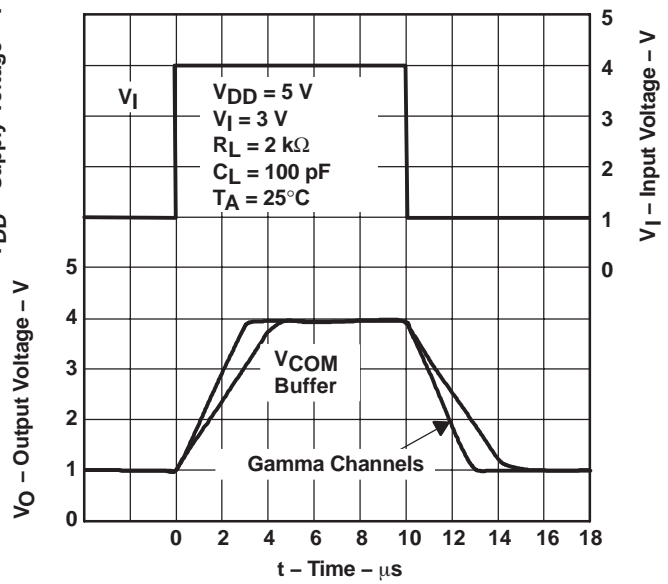

Figure 24

LARGE SIGNAL VOLTAGE FOLLOWER

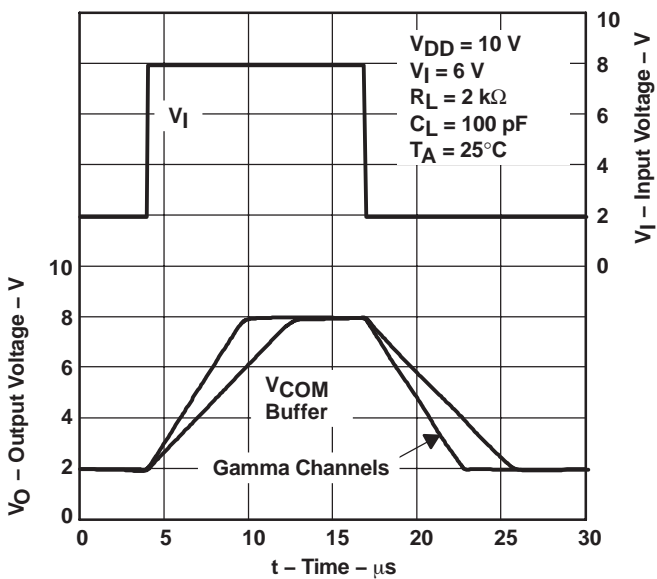

Figure 25

LARGE SIGNAL VOLTAGE FOLLOWER

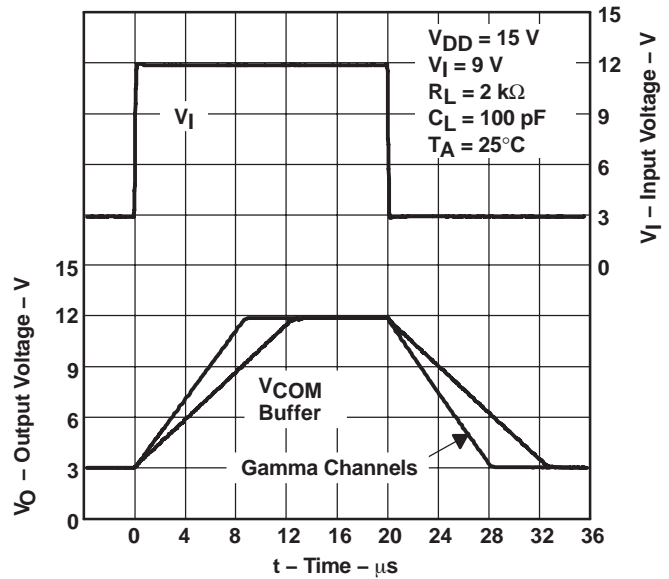

Figure 26

TYPICAL CHARACTERISTICS

TRANSIENT CURVES (continued)

SMALL SIGNAL VOLTAGE FOLLOWER

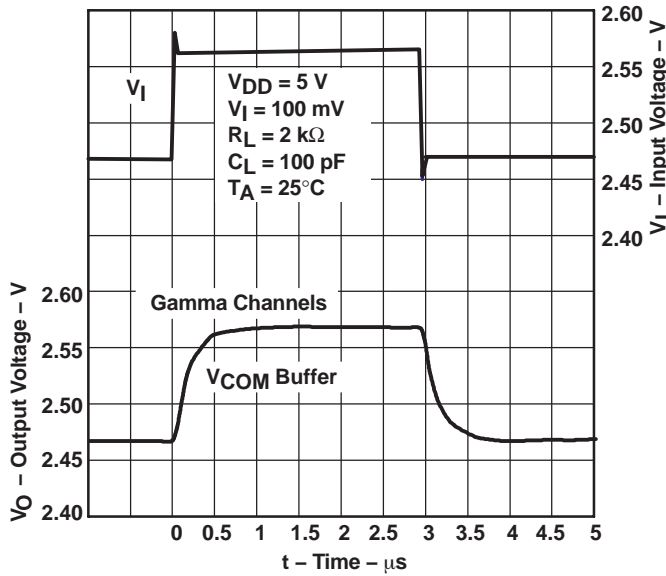

Figure 27

SMALL SIGNAL PULSE RESPONSE

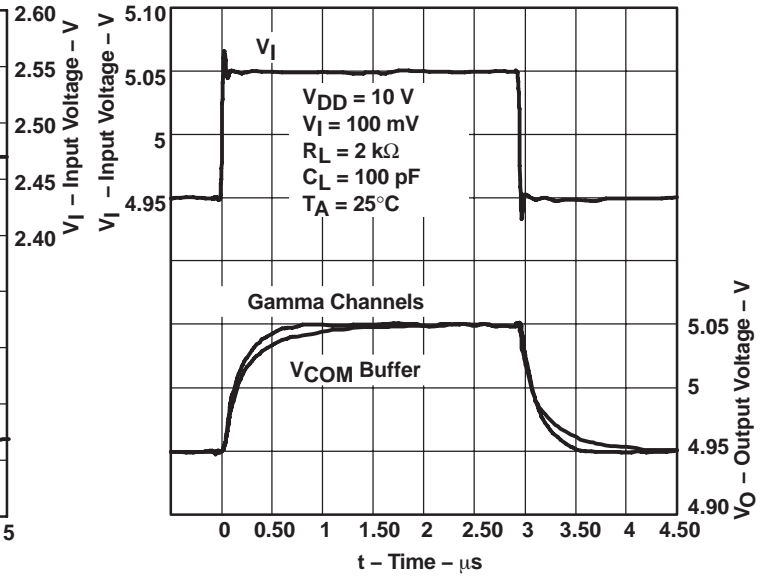

Figure 28

SMALL SIGNAL VOLTAGE FOLLOWER

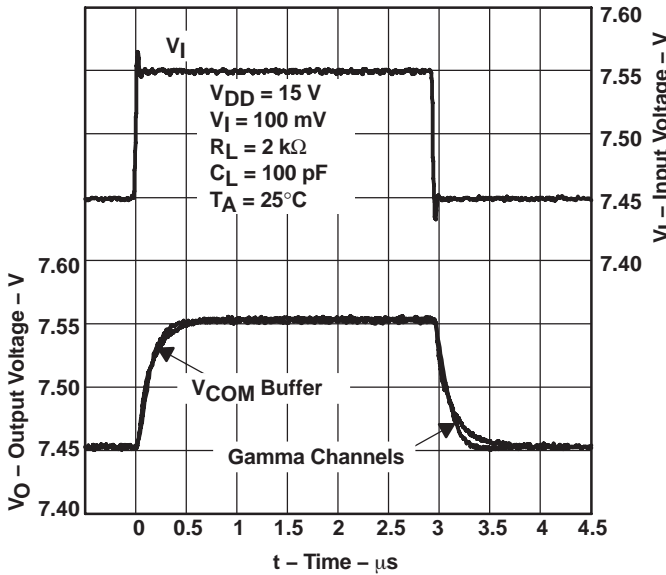

Figure 29

TRANSIENT LOAD RESPONSE – SOURCING

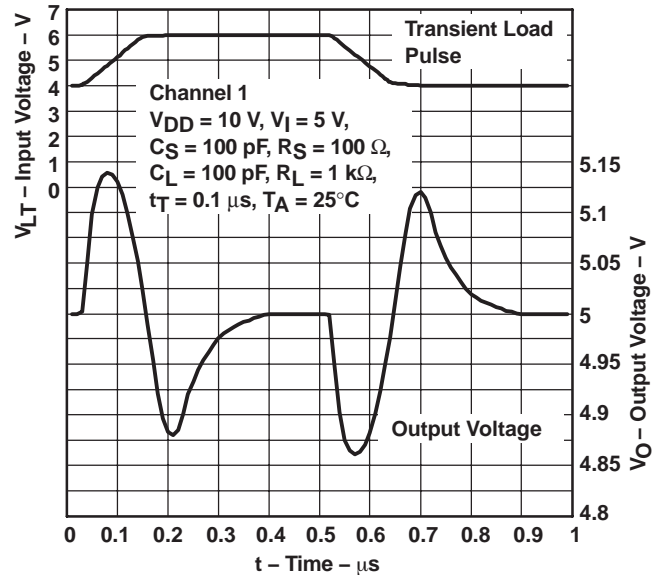

Figure 30

TYPICAL CHARACTERISTICS

TRANSIENT CURVES (continued)

TRANSIENT LOAD RESPONSE – SINKING

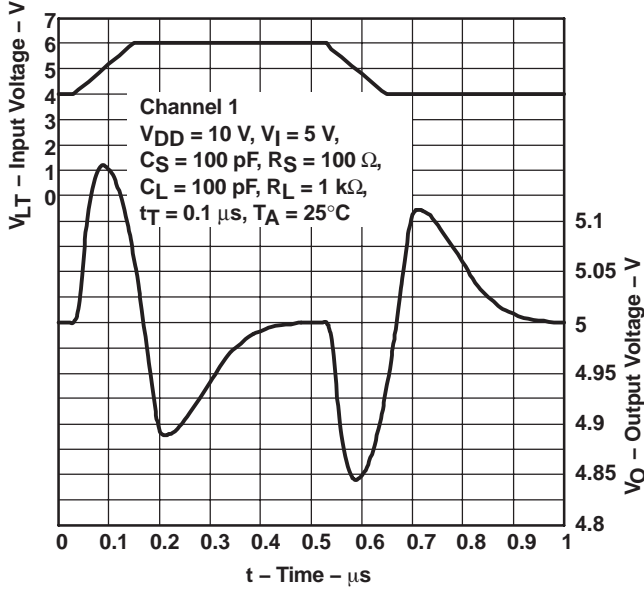

Figure 31

TRANSIENT LOAD REGULATION – SINKING

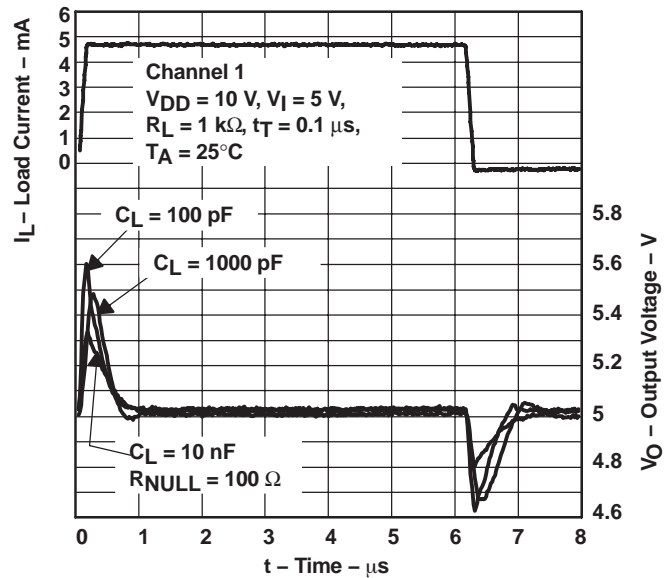

Figure 32

TRANSIENT LOAD REGULATION – SOURCING

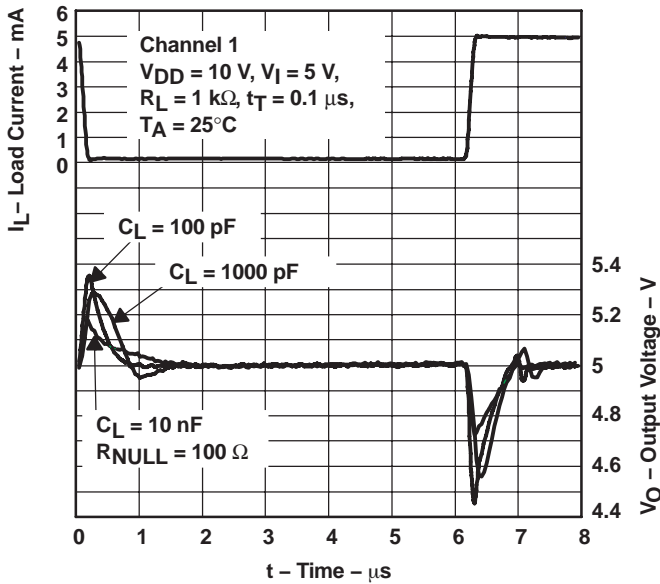

Figure 33

TRANSIENT LOAD REGULATION – V_{COM} BUFFER

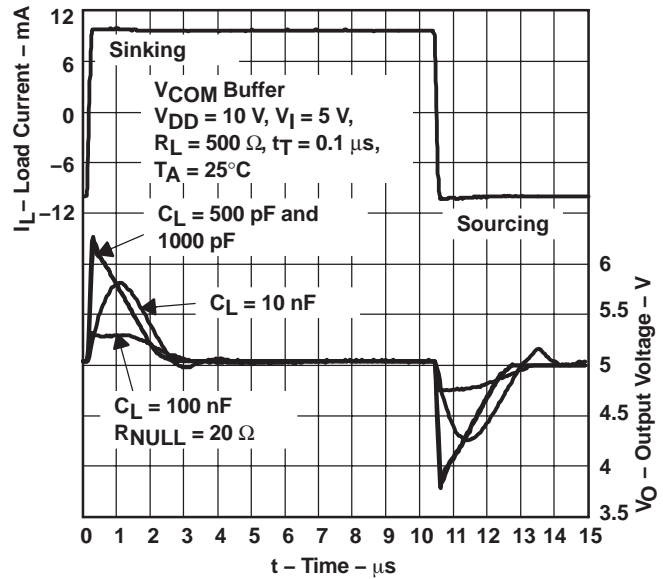

Figure 34

APPLICATION INFORMATION

The requirements on the number of gamma correction channels vary greatly from panel to panel. Therefore, the BUFxx703 series of gamma correction buffers offers different channel combinations. The V_{COM} channel can be used to drive the V_{COM} node on the LCD panel.

Gamma correction voltages are often generated using a simple resistor ladder, as shown in Figure 35. The

BUFxx703 buffers the various nodes on the gamma correction resistor ladder. The low output impedance of the BUFxx703 forces the external gamma correction voltage on the respective reference node of the LCD source driver. Figure 35 shows an example of the BUFxx703 in a typical block diagram driving an LCD source driver with 6-channel gamma correction reference inputs.

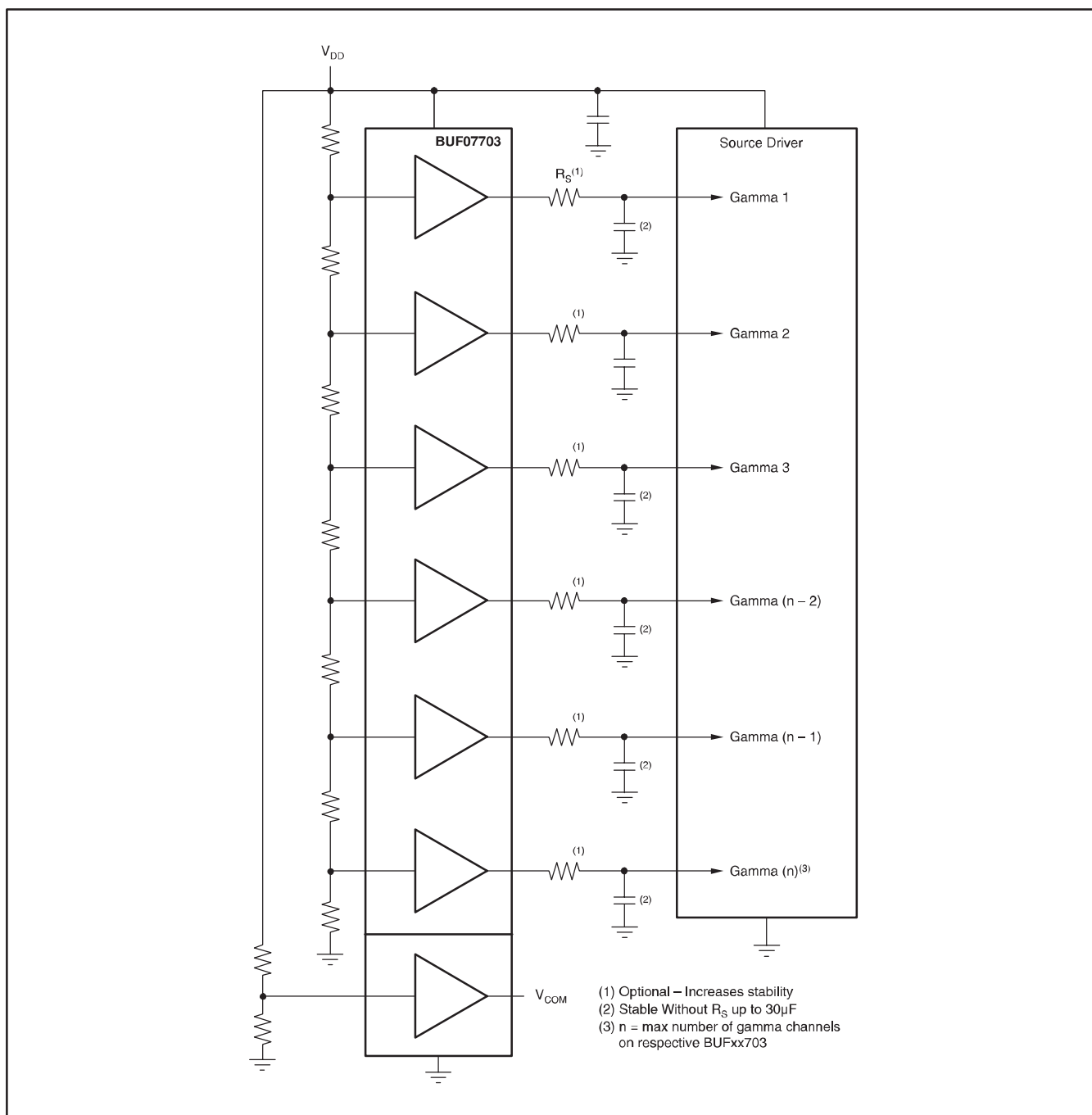

Figure 35. LCD Source Driver Typical Block Diagram.

INPUT VOLTAGE RANGE GAMMA BUFFERS

Figure 36 shows a typical gamma correction curve with 10 gamma correction reference points (GMA1 through GMA10). As can be seen from this curve, the voltage requirements for each buffer varies greatly. The swing capability of the input stages of the various buffers in the BUFxx703 is carefully matched to the application. Using the example of the BUF07703 with six gamma correction channels, buffers 1 to 3 have input stages that include V_{DD} , but will only swing within 1V to GND. Buffers 1 through 5 have only a single NMOS input stage. Buffers 4 through 6 have only a single PMOS input stage. The input range of the PMOS input stage includes GND.

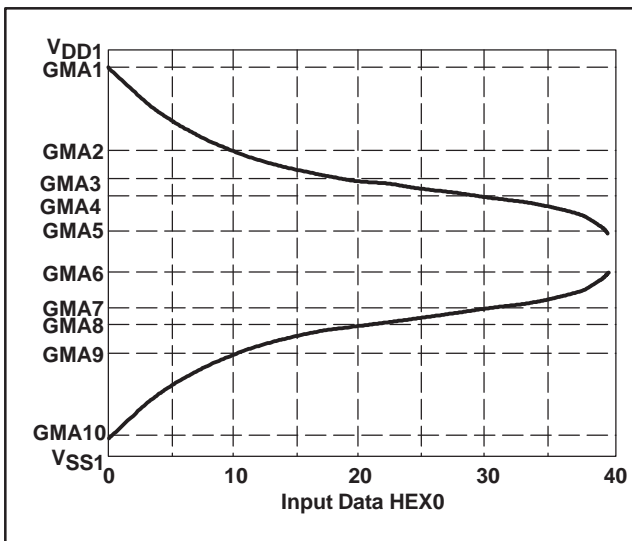

Figure 36. Gamma Correction Curve.

OUTPUT VOLTAGE SWING GAMMA BUFFERS

The output stages have been designed to match the characteristic of the input stage. Once again using the example of the BUF07703 means that the output stage of buffer 1 swings very close to V_{DD} , typically $V_{CC} - 100\text{mV}$ at 5mA; its ability to swing to GND is limited. Buffers 2 and 3 have smaller output stages with slightly larger output resistances, as they will not have to swing as close to the positive rail as buffer 1. Buffers 4 through 6 swing closer to GND than V_{DD} . Buffer 6 is designed to swing very close to GND, typically $\text{GND} + 100\text{mV}$ at a 5mA load current. See the typical characteristics for more details. This approach significantly reduces the silicon area and cost of the whole solution. However, due to this architecture, the correct buffer needs to be connected to the correct gamma correction voltage. Connect buffer 1 to the gamma voltage closest to V_{DD} , and buffers 2 and 3 to the sequential voltages. Buffer 6 should be connected to the gamma correction voltage closest to GND (or the negative rail), buffers 4 and 5 to the sequential higher voltages.

COMMON BUFFER (V_{COM})

The common buffer output of the BUF07703 and BUF05703 has a greater output drive capability than the gamma correction buffers, to meet the heavier current demands of driving the common node of the LCD panel. It was also designed to drive heavier capacitive loads and still remain stable, as shown in Figure 37.

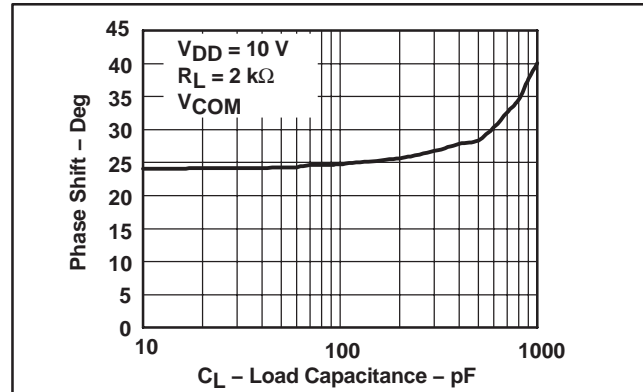

Figure 37. Phase Shift vs Load Capacitance.

CAPACITIVE LOAD DRIVE

The BUFxx703 has been designed to be able to sink/source DC currents in excess of 10mA. Its output stage has been designed to deliver output current transients with little disturbance of the output voltage. However, there are times when very fast current pulses are required. Therefore, in LCD source-driver buffer applications, it is quite normal for capacitors to be placed at the outputs of the reference buffers. These are to improve the transient load regulation. These will typically vary from 100pF and more. The BUFxx703 gamma buffers were designed to drive capacitances in excess of 100pF and retain effective phase margins above 50° , as shown in Figure 38.

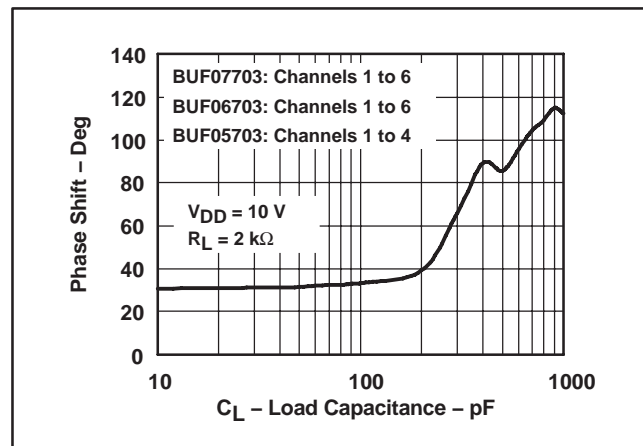

Figure 38. Phase Shift Between Output and Input vs Load Capacitance for the gamma buffers

APPLICATIONS WITH >10 GAMMA CHANNELS

When a greater number of gamma correction channels are required, two or more BUFxx703 devices can be used in parallel, as shown in Figure 39. This provides a cost-effective way of creating more reference voltages over the use of quad-channel op amps or buffers. The suggested configuration in Figure 39 simplifies layout. The various different channel versions provide a high degree of flexibility and also minimize total cost and space.

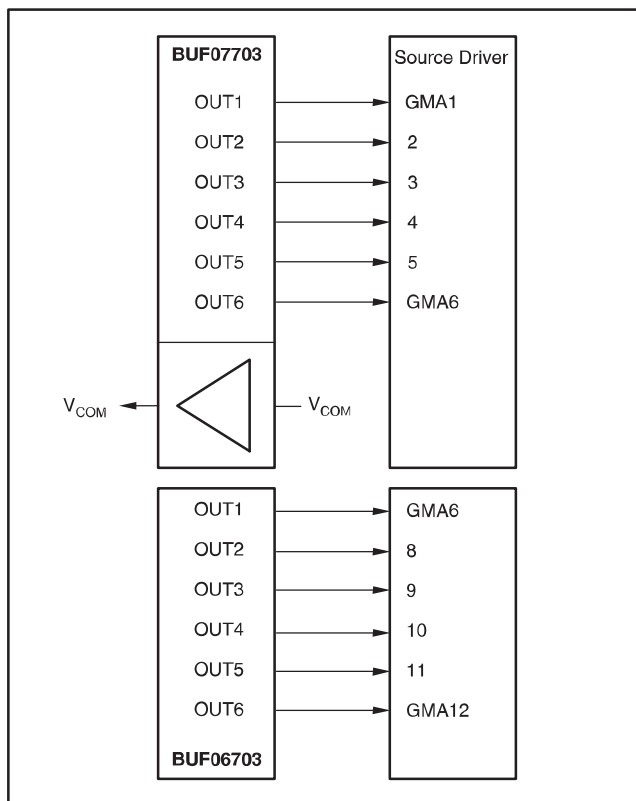

Figure 39. Creating > 10 Gamma Voltage Channels

Table 1. > 10 Channel Gamma Combinations

	BUF11702	BUF07703	BUF06703	BUF05703
12ch	—	—	2	—
12ch + V _{COM}	—	1	1	—
14ch + V _{COM}	1	—	—	1
16ch + V _{COM}	1	—	1	—
18ch + V _{COM}	2	—	—	—
20ch + V _{COM}	2	—	—	—

MULTIPLE V_{COM} CHANNELS

In some LCD panels, more than one V_{COM} driver is required for best panel performance. Figure 40 uses three BUF07703s to create a total of 18 gamma-correction and three V_{COM} channels. This solution saves considerable space and cost over the more conventional approach of using five or six quad-channel buffers or op amps.

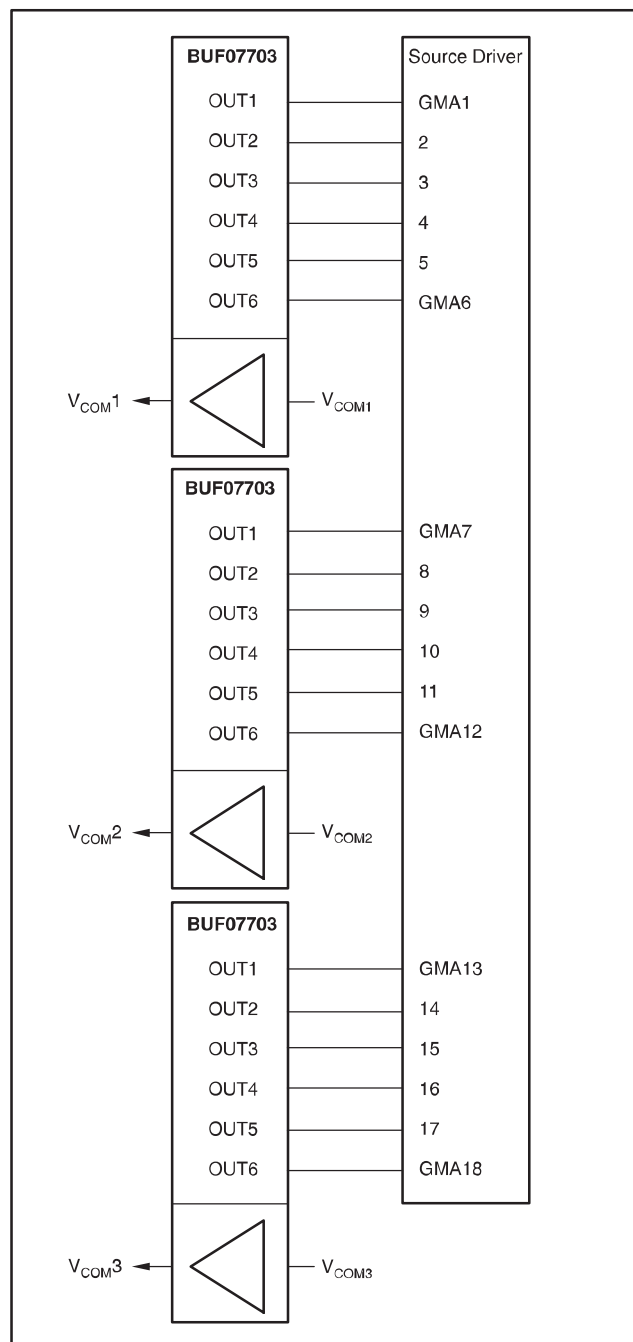

Figure 40. 18-Channel Application with Five Integrated V_{COM} Channels

COMPLETE LCD SOLUTION FROM TI

Besides the BUFxx703 line of gamma correction buffers, TI offers a complete set of ICs for the LCD panel market: source and gate drivers, various power-supply solutions, as well as audio power solutions. Figure 41 shows the Total IC solution from TI.

Audio Power Amplifier for TV Speakers

The TPA3002D2 is a 7W (per channel) stereo audio amplifier specifically targeted towards LCD monitors and TVs. It offers highly efficient, filter-free Class-D operation for driving bridged tied stereo speakers. The TPA3002D2 is designed to drive stereo speakers as low as 8Ω without an output filter. The high efficiency of the TPA3002D2 eliminates the need for external heatsinks when playing music. Stereo speaker volume is controlled with a DC voltage applied to the volume control terminal offering a range of gain from -40dB to +36dB. Line outputs, for driving external headphone amplifier inputs, are also DC voltage controlled with a range of gain from -56dB to +20dB. An integrated +5V regulated supply is provided for powering an external headphone amplifier. Texas Instruments offers a full line of linear and switch-mode audio power amplifiers. For excellent audio performance TI recommends the

OPA364 or OPA353 as headphone drivers. For more information visit www.ti.com.

Integrated DC/DC Converter for LCD Panels: TPS65100

The TPS65100 offers a very compact and small power supply solution to provide all three power-supply voltages required by TFT (thin film transistor) LCD displays. Additionally the device has an integrated V_{COM} buffer. The auxiliary linear regulator controller can be used to generate the 3.3V logic power rail for systems powered by a 5V supply rail only. The main output can power the LCD source drivers as well as the BUFxx703. An integrated adjustable charge pump doubler/tripler provides the positive LCD gate drive voltage. An externally adjustable negative charge pump provides the negative gate drive voltage. The TPS65100 has an integrated V_{COM} buffer to power the LCD backplane. A version of the BUFxx703 without the integrated V_{COM} buffer could be used for minimum redundancy and lowest cost. For LCD panels powered by 5V only, the TPS65100 has a linear regulator controller that uses an external transistor to provide a regulated 3.3V output for the digital circuits. Contact the local sales office for more information.

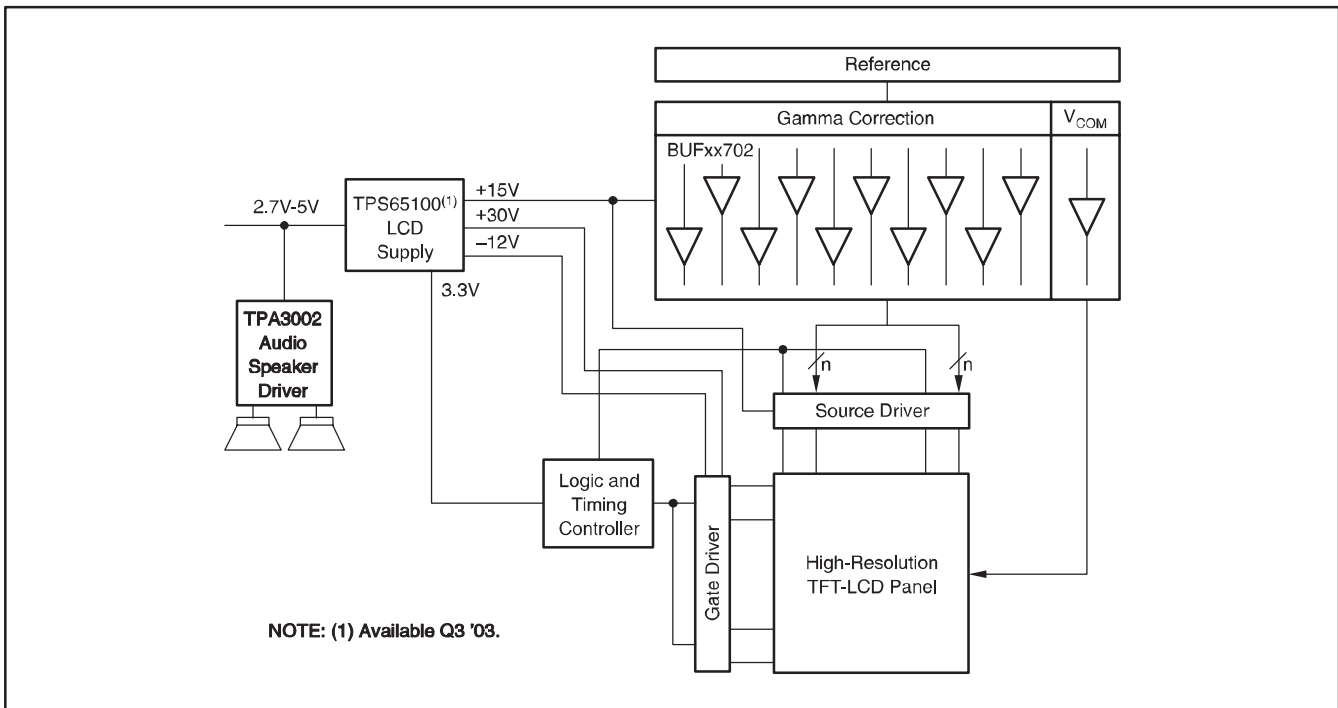

Figure 41. TI LCD Solution

GENERAL POWERPAD DESIGN CONSIDERATIONS

The BUF07703 is available in the thermally enhanced PowerPAD family of packages. These packages are constructed using a downset leadframe upon which the die is mounted; see Figure 42(a) and (b). This arrangement results in the lead frame being exposed as a thermal pad on the underside of the package; see Figure 42(c). Due to this thermal pad having direct thermal contact with the die, excellent thermal performance is achieved by providing a good thermal path away from the thermal pad.

The PowerPAD package allows for both assembly and thermal management in one manufacturing operation. During the surface-mount solder operation (when the leads are being soldered), the thermal pad can also be soldered to a copper area underneath the package. Through the use of thermal paths within this copper area, heat can be conducted away from the package into either a ground plane or other heat-dissipating device.

1. Prepare the PCB with a top-side etch pattern, (see Pin Configurations). There must be etching for the leads as well as etch for the thermal pad.
2. Place 18 holes in the area of the thermal pad. These holes must be 13 mils in diameter. Keep them small, so that solder wicking through the holes is not a problem during reflow.
3. Additional vias may be placed anywhere along the thermal plane outside of the thermal pad area. This helps dissipate the heat generated by the BUF07703 IC. These additional vias may be larger than the 13-mil diameter vias directly under the thermal pad. They can be larger because they are not in the thermal pad area to be soldered, so that wicking is not a problem.
4. Connect all holes to the internal ground plane.
5. When connecting these holes to the ground plane, do not use the typical web or spoke via connection methodology. Web connections have a high thermal

resistance connection that is useful for slowing the heat transfer during soldering operations. This makes the soldering of vias that have plane connections easier. In this application, however, low thermal resistance is desired for the most efficient heat transfer. Therefore, the holes under the BUF07703 PowerPAD package must make their connection to the internal ground plane with a complete connection around the entire circumference of the plated-through hole.

6. The top-side solder mask must leave the terminals of the package and the thermal pad area with its five holes (dual) or nine holes (quad) exposed. The bottom-side solder mask must cover the five or nine holes of the thermal pad area. This prevents solder from being pulled away from the thermal pad area during the reflow process.
7. Apply solder paste to the exposed thermal pad area and all of the IC terminals.
8. With these preparatory steps in place, the BUF07703 IC is simply placed in position and run through the solder reflow operation as any standard surface-mount component. This results in a part that is properly installed.

For a given θ_{JA} , the maximum power dissipation is calculated by the following formula:

$$P_D = \left(\frac{T_{MAX} - T_A}{\theta_{JA}} \right)$$

Where:

- P_D = maximum power dissipation (W)
- T_{MAX} = absolute maximum junction temperature (150°C)
- T_A = free-ambient air temperature (°C)
- $\theta_{JA} = \theta_{JC} + \theta_{CA}$
- θ_{JC} = thermal coefficient from junction to case (°C/W)
- θ_{CA} = thermal coefficient from case-to-ambient air (°C/W)

This lower thermal resistance enables the BUF07703 to deliver maximum output currents even at high ambient temperatures.

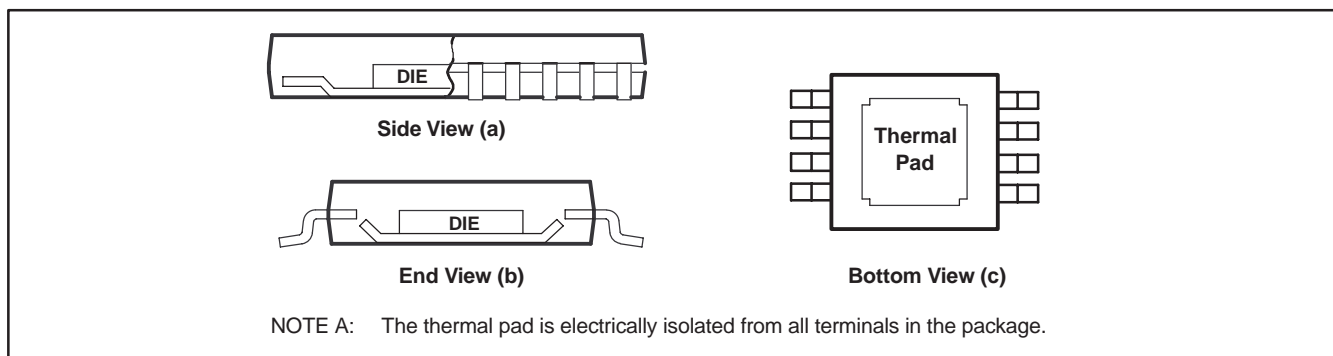

Figure 42. Views of Thermally Enhanced DGN Package

PACKAGING INFORMATION

Orderable Device	Status ⁽¹⁾	Package Type	Package Drawing	Pins	Package Qty	Eco Plan ⁽²⁾	Lead/Ball Finish	MSL Peak Temp ⁽³⁾
BUF05703PW	ACTIVE	TSSOP	PW	14	90	Green (RoHS & no Sb/Br)	CU NIPDAU	Level-1-260C-UNLIM
BUF05703PWG4	ACTIVE	TSSOP	PW	14	90	Green (RoHS & no Sb/Br)	CU NIPDAU	Level-1-260C-UNLIM
BUF05703PWR	ACTIVE	TSSOP	PW	14	2000	Green (RoHS & no Sb/Br)	CU NIPDAU	Level-1-260C-UNLIM
BUF05703PWRG4	ACTIVE	TSSOP	PW	14	2000	Green (RoHS & no Sb/Br)	CU NIPDAU	Level-1-260C-UNLIM
BUF06703PW	ACTIVE	TSSOP	PW	16	90	Green (RoHS & no Sb/Br)	CU NIPDAU	Level-1-260C-UNLIM
BUF06703PWG4	ACTIVE	TSSOP	PW	16	90	Green (RoHS & no Sb/Br)	CU NIPDAU	Level-1-260C-UNLIM
BUF06703PWR	ACTIVE	TSSOP	PW	16	2000	Green (RoHS & no Sb/Br)	CU NIPDAU	Level-1-260C-UNLIM
BUF06703PWRG4	ACTIVE	TSSOP	PW	16	2000	Green (RoHS & no Sb/Br)	CU NIPDAU	Level-1-260C-UNLIM
BUF07703PWP	ACTIVE	HTSSOP	PWP	20	70	Green (RoHS & no Sb/Br)	CU NIPDAU	Level-2-260C-1 YEAR
BUF07703PWPG4	ACTIVE	HTSSOP	PWP	20	70	Green (RoHS & no Sb/Br)	CU NIPDAU	Level-2-260C-1 YEAR
BUF07703PWPR	ACTIVE	HTSSOP	PWP	20	2000	Green (RoHS & no Sb/Br)	CU NIPDAU	Level-2-260C-1 YEAR
BUF07703PWPRG4	ACTIVE	HTSSOP	PWP	20	2000	Green (RoHS & no Sb/Br)	CU NIPDAU	Level-2-260C-1 YEAR

⁽¹⁾ The marketing status values are defined as follows:

ACTIVE: Product device recommended for new designs.

LIFEBUY: TI has announced that the device will be discontinued, and a lifetime-buy period is in effect.

NRND: Not recommended for new designs. Device is in production to support existing customers, but TI does not recommend using this part in a new design.

PREVIEW: Device has been announced but is not in production. Samples may or may not be available.

OBSOLETE: TI has discontinued the production of the device.

⁽²⁾ Eco Plan - The planned eco-friendly classification: Pb-Free (RoHS), Pb-Free (RoHS Exempt), or Green (RoHS & no Sb/Br) - please check <http://www.ti.com/productcontent> for the latest availability information and additional product content details.

TBD: The Pb-Free/Green conversion plan has not been defined.

Pb-Free (RoHS): TI's terms "Lead-Free" or "Pb-Free" mean semiconductor products that are compatible with the current RoHS requirements for all 6 substances, including the requirement that lead not exceed 0.1% by weight in homogeneous materials. Where designed to be soldered at high temperatures, TI Pb-Free products are suitable for use in specified lead-free processes.

Pb-Free (RoHS Exempt): This component has a RoHS exemption for either 1) lead-based flip-chip solder bumps used between the die and package, or 2) lead-based die adhesive used between the die and leadframe. The component is otherwise considered Pb-Free (RoHS compatible) as defined above.

Green (RoHS & no Sb/Br): TI defines "Green" to mean Pb-Free (RoHS compatible), and free of Bromine (Br) and Antimony (Sb) based flame retardants (Br or Sb do not exceed 0.1% by weight in homogeneous material)

⁽³⁾ MSL, Peak Temp. -- The Moisture Sensitivity Level rating according to the JEDEC industry standard classifications, and peak solder temperature.

Important Information and Disclaimer: The information provided on this page represents TI's knowledge and belief as of the date that it is provided. TI bases its knowledge and belief on information provided by third parties, and makes no representation or warranty as to the accuracy of such information. Efforts are underway to better integrate information from third parties. TI has taken and continues to take reasonable steps to provide representative and accurate information but may not have conducted destructive testing or chemical analysis on incoming materials and chemicals. TI and TI suppliers consider certain information to be proprietary, and thus CAS numbers and other limited information may not be available for release.

In no event shall TI's liability arising out of such information exceed the total purchase price of the TI part(s) at issue in this document sold by TI to Customer on an annual basis.

TAPE AND REEL INFORMATION



QUADRANT ASSIGNMENTS FOR PIN 1 ORIENTATION IN TAPE



*All dimensions are nominal

Device	Package Type	Package Drawing	Pins	SPQ	Reel Diameter (mm)	Reel Width W1 (mm)	A0 (mm)	B0 (mm)	K0 (mm)	P1 (mm)	W (mm)	Pin1 Quadrant
BUF05703PWR	TSSOP	PW	14	2000	330.0	12.4	6.67	5.4	1.6	8.0	12.0	Q1
BUF06703PWR	TSSOP	PW	16	2000	330.0	12.4	6.67	5.4	1.6	8.0	12.0	Q1
BUF06703PWR	TSSOP	PW	16	2000	330.0	12.4	7.0	5.6	1.6	8.0	12.0	Q1
BUF07703PWPR	HTSSOP	PWP	20	2000	330.0	16.4	6.95	7.1	1.6	8.0	16.0	Q1
BUF07703PWPRG4	HTSSOP	PWP	20	2000	330.0	16.4	6.95	7.1	1.6	8.0	16.0	Q1

TAPE AND REEL BOX DIMENSIONS



*All dimensions are nominal

Device	Package Type	Package Drawing	Pins	SPQ	Length (mm)	Width (mm)	Height (mm)
BUF05703PWR	TSSOP	PW	14	2000	346.0	346.0	29.0
BUF06703PWR	TSSOP	PW	16	2000	346.0	346.0	29.0
BUF06703PWR	TSSOP	PW	16	2000	346.0	346.0	29.0
BUF07703PWPR	HTSSOP	PWP	20	2000	346.0	346.0	33.0
BUF07703PWPRG4	HTSSOP	PWP	20	2000	346.0	346.0	33.0

PW (R-PDSO-G**)

PLASTIC SMALL-OUTLINE PACKAGE

14 PINS SHOWN



4040064/F 01/97

- NOTES: A. All linear dimensions are in millimeters.
 B. This drawing is subject to change without notice.
 C. Body dimensions do not include mold flash or protrusion not to exceed 0,15.
 D. Falls within JEDEC MO-153

PWP (R-PDSO-G**) 20 PIN SHOWN

PowerPAD™ PLASTIC SMALL-OUTLINE PACKAGE

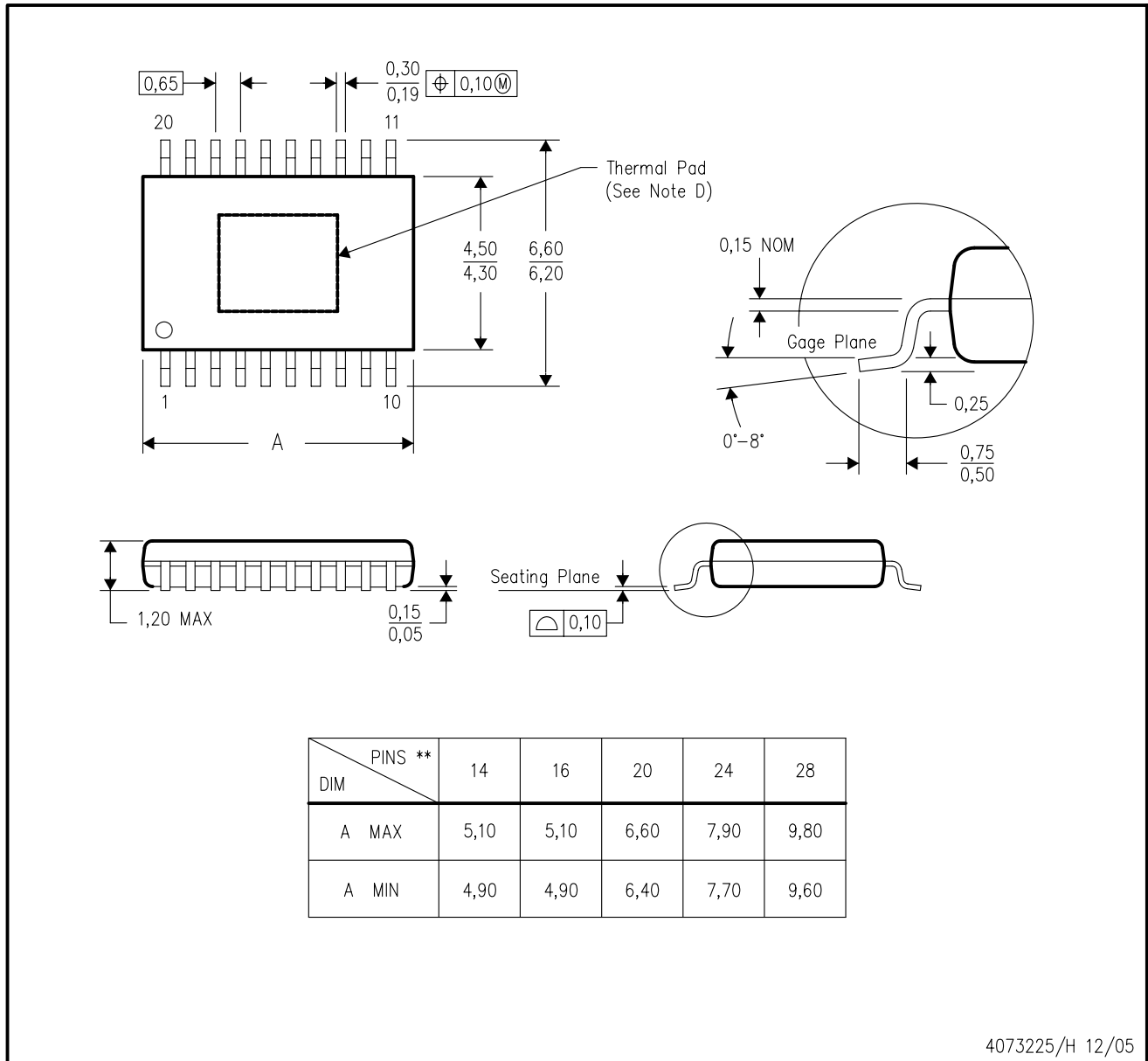

4073225/H 12/05

- NOTES:
- A. All linear dimensions are in millimeters.
 - B. This drawing is subject to change without notice.
 - C. Body dimensions do not include mold flash or protrusions. Mold flash and protrusion shall not exceed 0.15 per side.
 - D. This package is designed to be soldered to a thermal pad on the board. Refer to Technical Brief, PowerPad Thermally Enhanced Package, Texas Instruments Literature No. SLMA002 for information regarding recommended board layout. This document is available at www.ti.com <<http://www.ti.com>>.
 - E. Falls within JEDEC MO-153

PowerPAD is a trademark of Texas Instruments.

THERMAL INFORMATION

This PowerPAD™ package incorporates an exposed thermal pad that is designed to be attached to a printed circuit board (PCB). The thermal pad must be soldered directly to the PCB. After soldering, the PCB can be used as a heatsink. In addition, through the use of thermal vias, the thermal pad can be attached directly to the appropriate copper plane shown in the electrical schematic for the device, or alternatively, can be attached to a special heatsink structure designed into the PCB. This design optimizes the heat transfer from the integrated circuit (IC).

For additional information on the PowerPAD package and how to take advantage of its heat dissipating abilities, refer to Technical Brief, PowerPAD Thermally Enhanced Package, Texas Instruments Literature No. SLMA002 and Application Brief, PowerPAD Made Easy, Texas Instruments Literature No. SLMA004. Both documents are available at www.ti.com.

The exposed thermal pad dimensions for this package are shown in the following illustration.

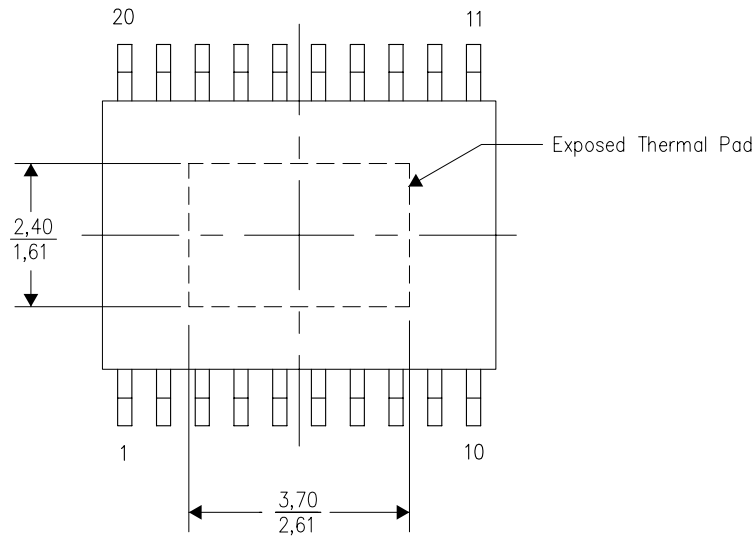

Top View

NOTE: All linear dimensions are in millimeters

Exposed Thermal Pad Dimensions

PWP (R-PDSO-G20) PowerPAD™

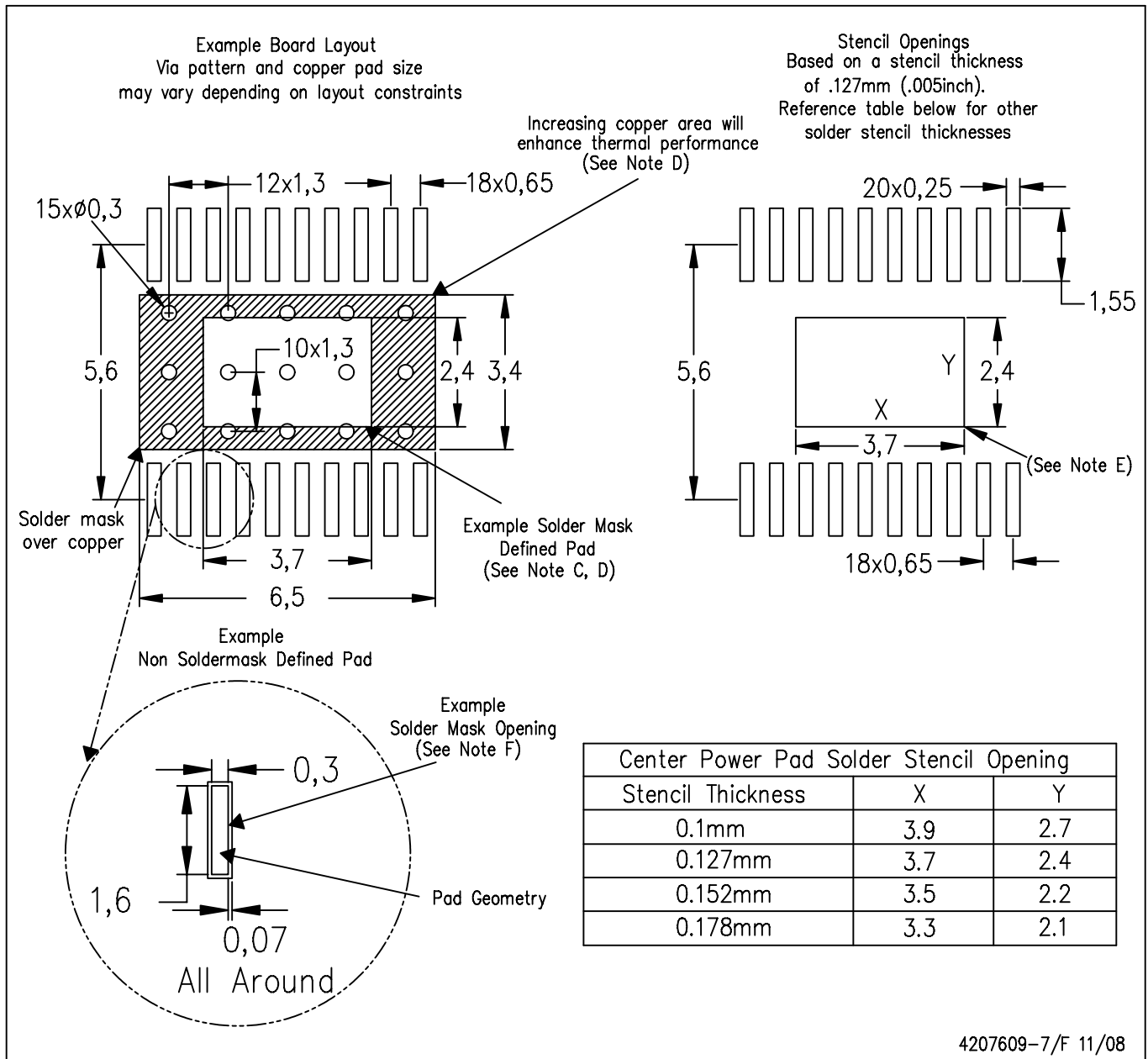

- NOTES:
- All linear dimensions are in millimeters.
 - This drawing is subject to change without notice.
 - Customers should place a note on the circuit board fabrication drawing not to alter the center solder mask defined pad.
 - This package is designed to be soldered to a thermal pad on the board. Refer to Technical Brief, PowerPad Thermally Enhanced Package, Texas Instruments Literature No. SLMA002, SLMA004, and also the Product Data Sheets for specific thermal information, via requirements, and recommended board layout. These documents are available at www.ti.com <<http://www.ti.com>>. Publication IPC-7351 is recommended for alternate designs.
 - Laser cutting apertures with trapezoidal walls and also rounding corners will offer better paste release. Customers should contact their board assembly site for stencil design recommendations. Example stencil design based on a 50% volumetric metal load solder paste. Refer to IPC-7525 for other stencil recommendations.
 - Customers should contact their board fabrication site for solder mask tolerances between and around signal pads.

PowerPAD is a trademark of Texas Instruments.

IMPORTANT NOTICE

Texas Instruments Incorporated and its subsidiaries (TI) reserve the right to make corrections, modifications, enhancements, improvements, and other changes to its products and services at any time and to discontinue any product or service without notice. Customers should obtain the latest relevant information before placing orders and should verify that such information is current and complete. All products are sold subject to TI's terms and conditions of sale supplied at the time of order acknowledgment.

TI warrants performance of its hardware products to the specifications applicable at the time of sale in accordance with TI's standard warranty. Testing and other quality control techniques are used to the extent TI deems necessary to support this warranty. Except where mandated by government requirements, testing of all parameters of each product is not necessarily performed.

TI assumes no liability for applications assistance or customer product design. Customers are responsible for their products and applications using TI components. To minimize the risks associated with customer products and applications, customers should provide adequate design and operating safeguards.

TI does not warrant or represent that any license, either express or implied, is granted under any TI patent right, copyright, mask work right, or other TI intellectual property right relating to any combination, machine, or process in which TI products or services are used. Information published by TI regarding third-party products or services does not constitute a license from TI to use such products or services or a warranty or endorsement thereof. Use of such information may require a license from a third party under the patents or other intellectual property of the third party, or a license from TI under the patents or other intellectual property of TI.

Reproduction of TI information in TI data books or data sheets is permissible only if reproduction is without alteration and is accompanied by all associated warranties, conditions, limitations, and notices. Reproduction of this information with alteration is an unfair and deceptive business practice. TI is not responsible or liable for such altered documentation. Information of third parties may be subject to additional restrictions.

Resale of TI products or services with statements different from or beyond the parameters stated by TI for that product or service voids all express and any implied warranties for the associated TI product or service and is an unfair and deceptive business practice. TI is not responsible or liable for any such statements.

TI products are not authorized for use in safety-critical applications (such as life support) where a failure of the TI product would reasonably be expected to cause severe personal injury or death, unless officers of the parties have executed an agreement specifically governing such use. Buyers represent that they have all necessary expertise in the safety and regulatory ramifications of their applications, and acknowledge and agree that they are solely responsible for all legal, regulatory and safety-related requirements concerning their products and any use of TI products in such safety-critical applications, notwithstanding any applications-related information or support that may be provided by TI. Further, Buyers must fully indemnify TI and its representatives against any damages arising out of the use of TI products in such safety-critical applications.

TI products are neither designed nor intended for use in military/aerospace applications or environments unless the TI products are specifically designated by TI as military-grade or "enhanced plastic." Only products designated by TI as military-grade meet military specifications. Buyers acknowledge and agree that any such use of TI products which TI has not designated as military-grade is solely at the Buyer's risk, and that they are solely responsible for compliance with all legal and regulatory requirements in connection with such use.

TI products are neither designed nor intended for use in automotive applications or environments unless the specific TI products are designated by TI as compliant with ISO/TS 16949 requirements. Buyers acknowledge and agree that, if they use any non-designated products in automotive applications, TI will not be responsible for any failure to meet such requirements.

Following are URLs where you can obtain information on other Texas Instruments products and application solutions:

Products

Amplifiers	amplifier.ti.com
Data Converters	dataconverter.ti.com
DSP	dsp.ti.com
Clocks and Timers	www.ti.com/clocks
Interface	interface.ti.com
Logic	logic.ti.com
Power Mgmt	power.ti.com
Microcontrollers	microcontroller.ti.com
RFID	www.ti-rfid.com
RF/IF and ZigBee® Solutions	www.ti.com/lprf

Applications

Audio	www.ti.com/audio
Automotive	www.ti.com/automotive
Broadband	www.ti.com/broadband
Digital Control	www.ti.com/digitalcontrol
Medical	www.ti.com/medical
Military	www.ti.com/military
Optical Networking	www.ti.com/opticalnetwork
Security	www.ti.com/security
Telephony	www.ti.com/telephony
Video & Imaging	www.ti.com/video
Wireless	www.ti.com/wireless

Mailing Address: Texas Instruments, Post Office Box 655303, Dallas, Texas 75265
Copyright © 2008, Texas Instruments Incorporated